

# ACCESS CONTROL



## STANDALONE KEYPADS AND PROXIMITY READERS

- (1) 500 user slots
- (2) PIN only, Prox only or Prox & PIN configurable
- (3) Lock output with additional auxiliary Input/Output on certain models (ideal for Auto Door Operators)
- (4) Tamper detection
- (5) Remote doorbell feature in-built

## AC-015 SINGLE DOOR CONTROLLER (500 USERS)

- (1) 16vac / 12v DC supply.
- (2) PIN or Prox readers can be used.
- (3) In / Out readers can be used.
- (4) Excellent F.O.C. PC reporting software included
- (5) Tamper detection
- (6) Battery charging unit
- (7) Controllers can also be left as standalone controllers

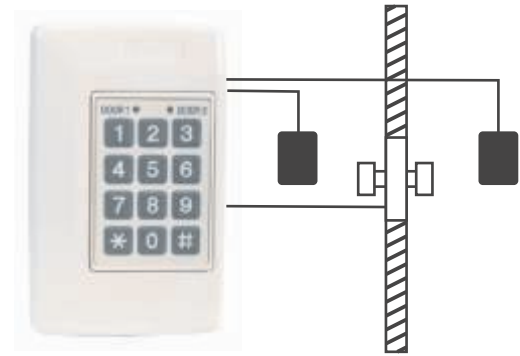

## AC-115 NETWORKABLE SINGLE DOOR CONTROLLER

- (1) 16vac / 12v DC supply.
- (2) PIN or Prox readers can be used.
- (3) In / Out readers can be used.
- (4) Excellent F.O.C. PC reporting software included with each controller
- (5) Capacity of system - 8 doors, 16 readers and 2400 users
- (6) Controllers can also be left as standalone controllers

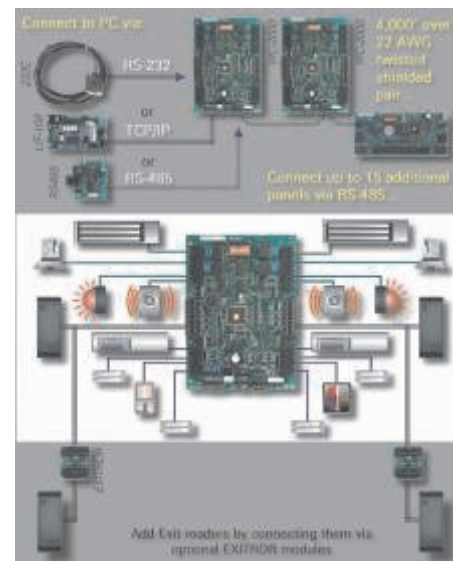
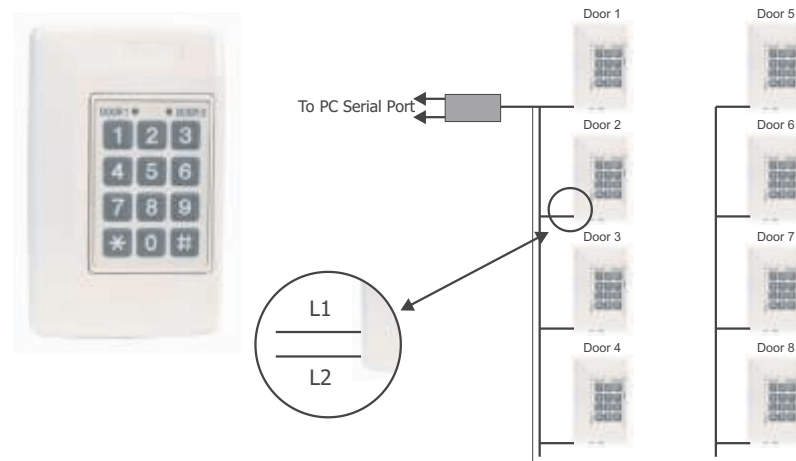

## IRC 2000 2 DOOR, 4 READER NETWORKABLE ACCESS CONTROL SYSTEM

- (1) Cabinets can be configured as single or dual door read in/out (i.e. 1-4 readers)
- (2) RS232, TCP/IP or RS485 networkable
- (3) 5000 cards per controller
- (4) 8 programmable inputs / outputs
- (5) 5000 access levels
- (6) 16 controllers per network



# ACCESSORIES

TSSI Systems Ltd offer the complete range of accessories to complete any access control/Intercom installation. There are too many to display on one page, so please contact us if you are looking for something a little bit different, or if you are having problems sourcing a solution. Our range covers electric releases, exit switches, Magnetic Locks, Solenoid Bolts, Electric Locks, Break Glass Units, Door Loops, PIR's, etc etc.

# WIRELESS ACCESS CONTROL

One of the fastest growing areas in access control is the wire-free solution. This technology has been used in hotels for many years, but we are now introducing several ranges which are suited to the commercial/domestic market.

Our ranges cover Dallas tokens, RFID cards/tokens, Fingerprint, PIN, and Smart Card technology. These systems can be PC based, or stand alone devices.



TSSI Systems Ltd., are a company which specialises in the supply of audio/video intercom systems, as well as Access Control products to the trade.

We have many years experience within this field, and are at the forefront of technology. Our main aim in business is to provide solutions to Access Control, and Intercom requirements, both on time, and within budget. Our expert engineers offer on-site assistance, as well as advice over the telephone.

We have a dedicated sales team who are fully versed in the current U.K & European standards affected within this industry. They are able to offer expert advice in not only Access Control, or Video Entry systems, but also in compatibility with many other systems (Systems integration). TSSI Systems Ltd offers a complete scheduling, and quotation service which is F.O.C.

We hope that you are able to find what you are looking for within the catalogue, but please feel free to contact us directly if you require any further assistance.



TSSI Systems Limited  
Rutland House  
Hargreaves Road  
Groundwell Ind. Est.  
Swindon  
SN25 5AZ  
United Kingdom

web: [www.tssi.co.uk](http://www.tssi.co.uk)  
e-mail: [info@tssi.co.uk](mailto:info@tssi.co.uk)  
tel: +44 (0)1793 747 700



# CM-06DN KITS (1 x ENT PANEL, 1 x INTERNAL UNIT, 1 x PSU)

1 way video kits - system can be expanded to two door and up to four internal video units. Internal and external units can be interchanged.

## CM-06DNS4G



- (1) One or two door stations can support up to four indoor phones.
- (2) 4" CRT B/W display, remote door locking.
- (3) LED in the door station provides a clear picture even in nighttime.
- (4) Surface-mounted design.
- (5) Intercom between internal units



## CM-06DNd2I



- (1) One or two door stations can support up to four indoor phones.
- (2) Hands free indoor phone, colour 5" or 5.6" TFT screen, remote door unlocking.
- (3) LED in the door station provides a clear picture even in nighttime.
- (4) Flush-mounted design.
- (5) Intercom between internal units



## CM-06DNS7V3



- (1) One or two door stations can support up to four indoor phones.
- (2) Hands free indoor phone, colour 3.5" TFT screen, remote door unlocking.
- (3) LED in the door station provides a clear picture even in nighttime.
- (4) Surface-mounted design.
- (5) Intercom between internal units.
- (6) Waterproof and heavy duty anti-vandal door station.



## CM-06DNS2V



- (1) One or two door stations can support up to four indoor phones.
- (2) Hands free indoor phone, colour 5" TFT screen, remote door unlocking.
- (3) LED in the door station provides a clear picture even in nighttime.
- (4) It is a pinhole camera, surface-mounted design.
- (5) Intercom between internal units.
- (6) Waterproof and heavy duty anti-vandal door station.



### ACCESSORIES

CM-06DNQH  
2 DOOR SWITCHER



SS220  
SURFACE SHROUD FOR  
CM-06DNd2I PANEL



PS-3E  
15V PSU FOR  
CM-06DNQH



PS-6E  
18V PSU FOR  
INTERNAL UNITS



# CM-02NE (VIDEO) & WL-02NE (AUDIO)

These systems are generally installed in apartments blocks. System capacity - 2 x entrance panels, and 32 apartments. Up to 4 units (audio or video) can be fitted in each apartment.

## CM-02NE (VIDEO)

- (1) Two door station can support up to thirty-two indoor phones.
- (2) LED in the door station provides a clear picture even in nighttime.
- (3) Different door station panels are available including stainless steel.
- (4) Different styles of internal units can be used on one system.
- (5) Doorbell style call-tone

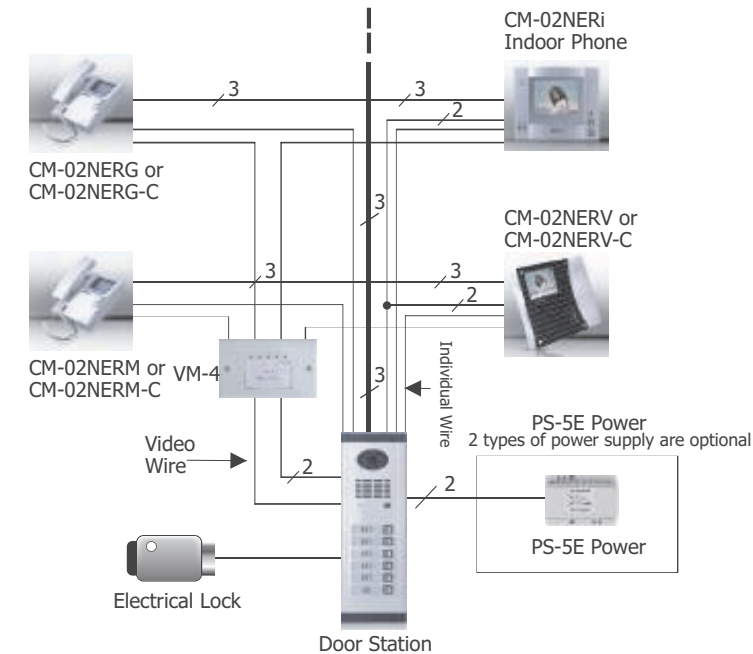
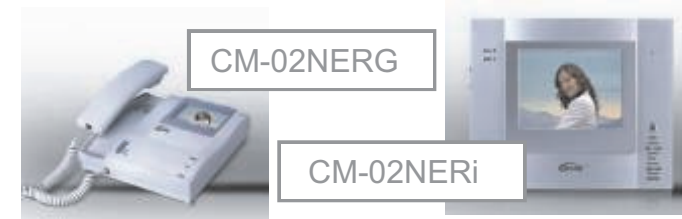

Products shown in diagrams are for illustration purposes only.

## WL-02NE (AUDIO 2 WIRE)

- (1) Two door station can support up to thirty-two indoor phones.
- (2) Different door station panels are available including stainless steel.
- (3) Non polarity conscious cabling to internal units
- (4) Doorbell style call tone



WL-02NEFC

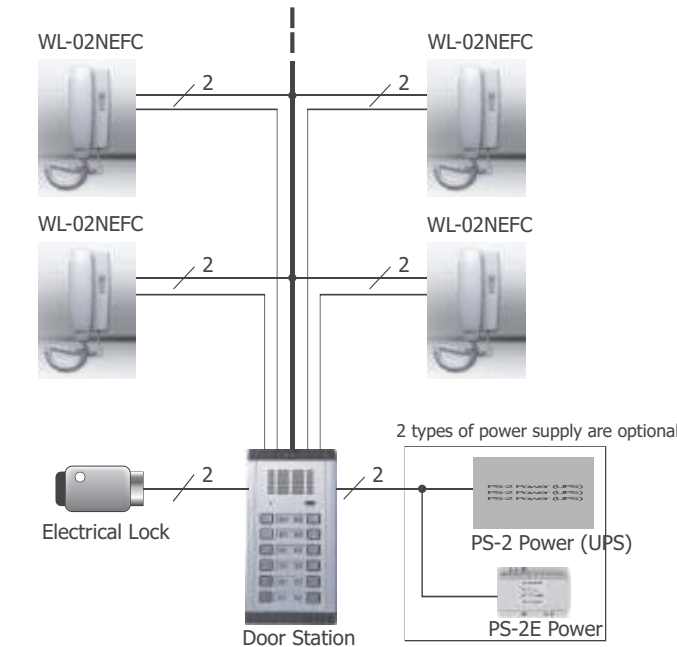

Products shown in diagrams are for illustration purposes only.

### ACCESSORIES



SURFACE SHROUD (AVAILABLE IN VARIOUS SIZES)



TD66 & LCU TIMELOCK FOR SERVICE/TRADES FACILITY



PS-5E 18V PSU



PS-2E 12V PSU



PS-2A BOXED 12V PSU

# CM-03NL (VIDEO) OR WL-03NL (AUDIO)

These systems are generally installed in large apartments / commercial premises. System capacity - 400 apartments from a single door. Doors may then be networked together with perimeter panels/concierge units added.

## ENTRANCE PANEL OPTIONS

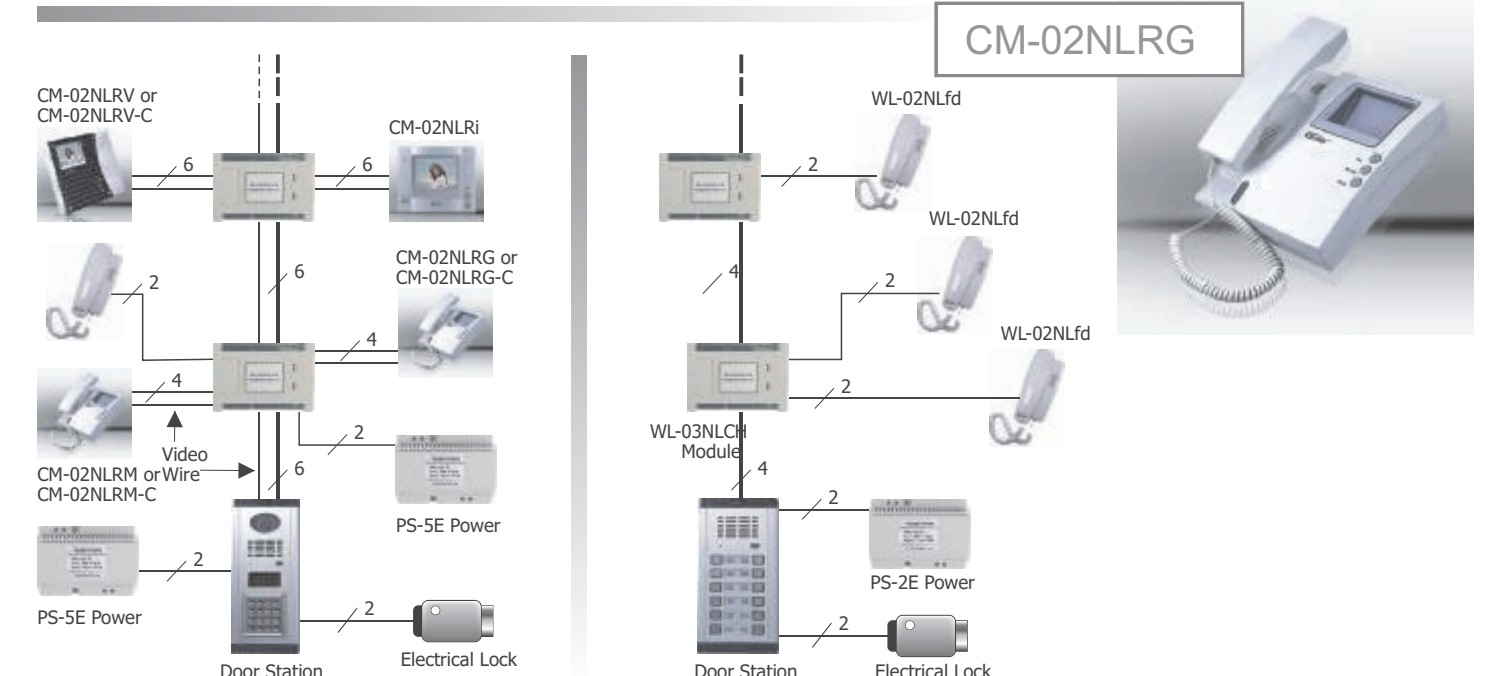

Products shown in diagrams are for illustration purposes only.

### ACCESSORIES



CM-03NQH NETWORK SWITCH

CM-03NLCH-162  
4 WAY MODULE



PS-5E 18V PSU



CM-03NMC CONCERGE UNIT